

DATA SHEET - OPERATION MANUAL

APPLICATION

Directional spool valves type UREP10... electro-hydraulically operated are intended for change in direction of fluid flow in a system and thus it allows to change direction of movement of a receiver - mostly piston rod of a cylinder or hydraulic motor as well to use functions: *on* and *off*. These directional spool valves are used for subplate mounting in any position in a hydraulic system.

The product is compliant with the regulations of directive 2014/35/UE.

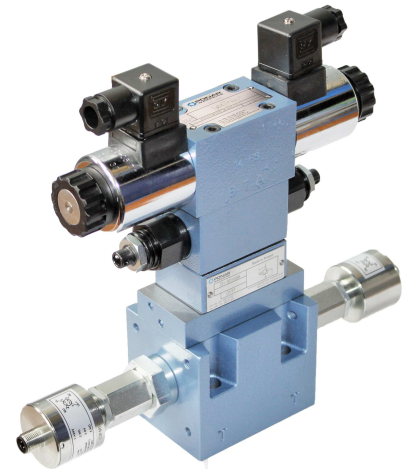

DESCRIPTION OF OPERATION

4UREP10 E 62/G24 N Z4

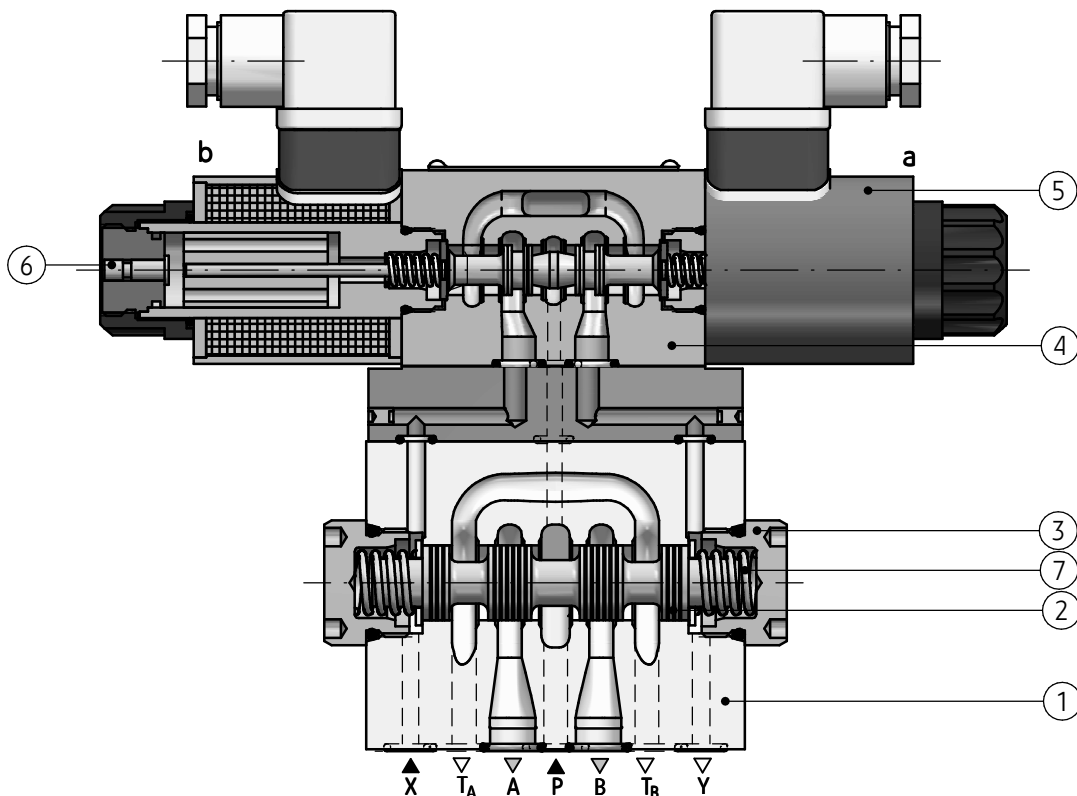

Main bore and annular ports **P**, **T**, **A**, **B** are made in the housing (1) and connected to its subplate connection. Directional valve is switched by shifting the spool (2) into one end position. Various control functions are dependent on the spool (2) which affects the change in configuration of connections among ports **P**, **T**, **A**, **B** in the housing (1). The spool (2) is shifted from its neutral

position by affecting pressure of hydraulic fluid supplied via pilot valve (4) into one chamber of caps (3). The pilot valve (4) - type **WE6**... is operated by means of solenoids (5). The spool (2) is centered in neutral position by means of springs (7). In case of failure, the pilot valve (4) may be shifted manually by means of manual overrides (6) - version UREP10.../...N.

DESCRIPTION OF OPERATION

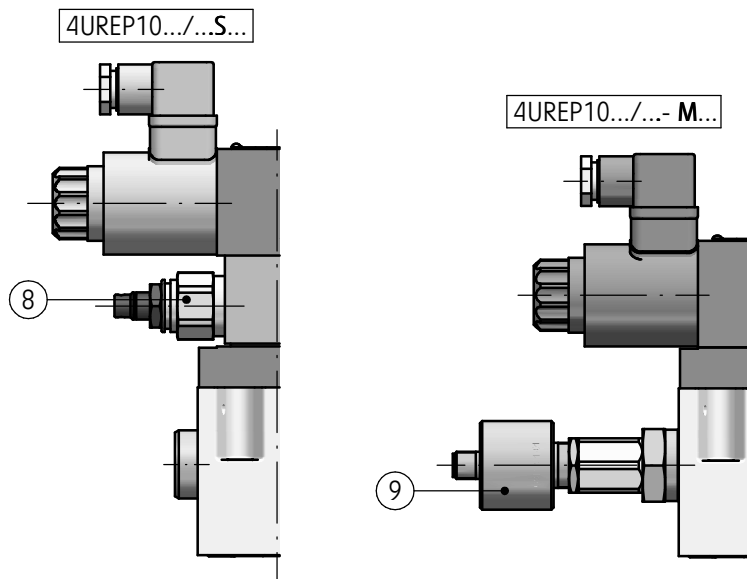

Directional spool valve type **UREP10...** can be provided with the pilot choke adjustment (8) and/or spool position sensor (9). Accessories can be mounted

depending on version of directional valve like given on pages 12 to 17.

INSTALLATION AND OPERATION REQUIREMENTS

1. Only fully functional and operational directional valve, properly connected to electrical installation must be used.
Connecting or disconnecting the directional valve to an electrical installation must only be carried out by qualified personnel.
2. Ground connection (PE) must be connected with protective earth wire (PE) in supply system according to appropriate instructions.
3. Solenoid plug shall precisely adhere to socket and shall be secured with thread bolt screwed in securely in a place. It is forbidden to operate the directional valve if the tightness and suitable clamp of cable in the plug gland are not ensured.
4. During the period of operation must be kept fluid viscosity acc. to requirements defined in this Data Sheet - Operation Manual.
5. In order to ensure failure free and safe operation the following must be checked:
 - condition of the electrical connection
 - proper working of the directional valve
 - cleanliness of the hydraulic fluid
6. Due to heating of solenoid coils to high temp., the directional valve shall be placed in such way to eliminate the risk of accidental contact with solenoid during operation or to apply suitable covers acc. to European standards: PN - EN ISO 13732 - 1 and PN - EN 4413.
7. In order to ensure tightness of the directional valve block, one should take care of dimension of sealing rings, tightening torques and valve operation parameters given in this Data Sheet - Operation Manual.
8. Any changes, modifications or adjustments to the versions with M type spool position sensor can be made only by the producer - see notes on page 16.
9. A person that operates the directional valve must be thoroughly familiar with this Data Sheet - Operation Manual.

TECHNICAL DATA

Hydraulic fluid	mineral oil						
Required fluid cleanliness class	ISO 4406 class 20/18/15						
Nominal fluid viscosity	37 mm ² /s at temperature 55 °C						
Viscosity range	2,8 up to 380 mm ² /s						
Fluid temperature range (in a tank)	recommended	40°C up to 55°C					
	max	-20°C up to +70°C					
Ambient temperature range	- 20°C up to +50°C						
Maximum operating pressure	ports P, A, B	35 MPa					
	port T	21 MPa					
Pilot pressure (X)	min 1,5 MPa						
	max 25 MPa						
Pilot valve type	WE6... acc. to data sheet WK 420 970						
Pilot valve version <ul style="list-style-type: none"> • for 3-position main directional valve • for 2-position main directional valve (a, 0) • for 2-position main directional valve (0, b) • for 2-position main directional valve (a, b) 	4WE6...J... 4WE6...JA... 4WE6...JB... 4WE6...D...						
Supply voltage of solenoids	DC			AC (plug-in connector with rectifier)			
	12V	24V	110V	110V - 50Hz	220V - 50Hz	230V - 50Hz	
Supply voltage tolerance Power requirement (DC) Degree of protection Temperature of solenoid coil	±10% 30 W IP 65 max 150 °C						
Weight	directional valve version					3-position	2-position
	4UREP10...					6,4 kg	5,8 kg
	4UREP10...S...					7,3 kg	6,7 kg
	4UREP10...S...D1					7,8 kg	7,2 kg
	4UREP10...- M0...; ...- MA...; ...- MB...					6,9 kg	6,3 kg
	4UREP10...S...- M0...D1; ...- MA...D1; ...- MA...D1					8,3 kg	7,7 kg
	4UREP10...- MAB...					7,3 kg	-
	4UREP10...S...- MAB...D1					8,8 kg	-

DIAGRAMS

Hydraulic diagrams for 3-position versions 4UREP10... with various pilot supply (X) and pilot drain (Y)

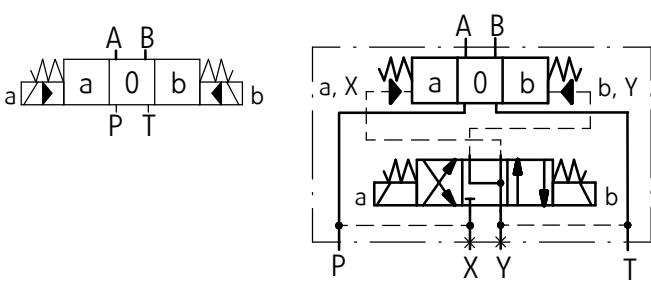
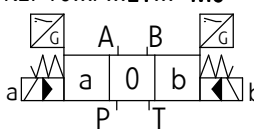
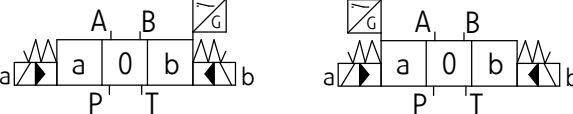
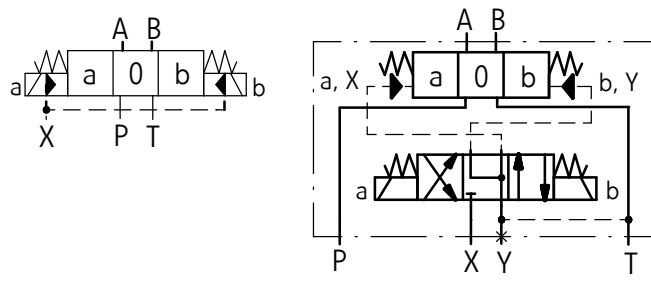
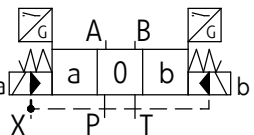
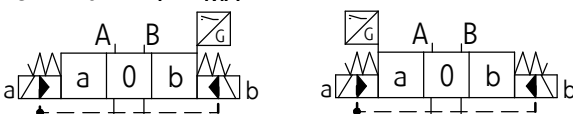
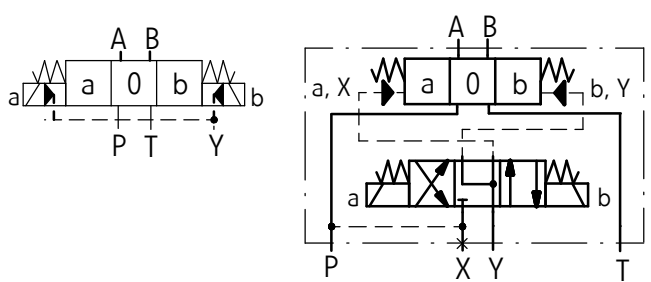
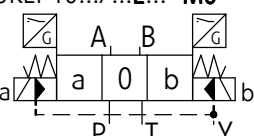
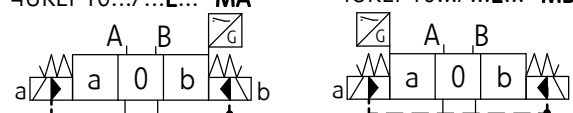
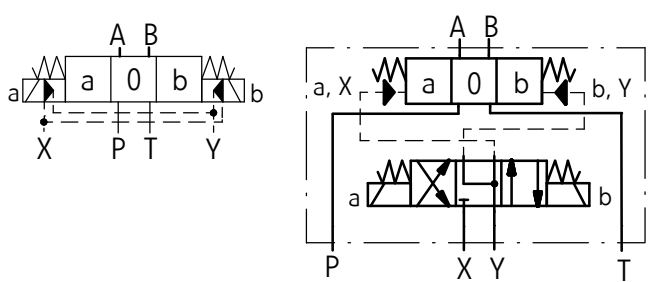
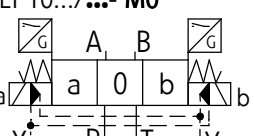
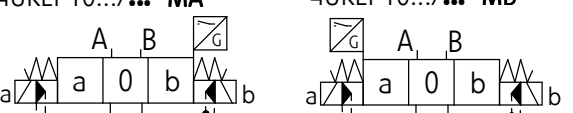
<p>simplified and detailed diagrams for standard 3-position versions 4UREP10...</p>	<p>simplified diagrams for 3-position versions with a type M spool position sensor 4UREP10.../...- M...</p>
<p>internal supply (X); internal drain (Y) - configuration not available for versions with spools G, H (diagrams acc. to page 7)</p>	
<p>version 4UREP10.../...ET...</p> 	<p>versions: 4UREP10.../...ET...- MAB; 4UREP10.../...ET...- M0</p>  <p>4UREP10.../...ET...- MA 4UREP10.../...ET...- MB</p> 
<p>external supply (X); internal drain (Y)</p>	
<p>version 4UREP10.../...T...</p> 	<p>versions: 4UREP10.../...T...- MAB; 4UREP10.../...T...- M0</p>  <p>4UREP10.../...T...- MA 4UREP10.../...T...- MB</p> 
<p>internal supply (X); external drain (Y) - configuration not available for versions with spools G, H (diagrams acc. to page 7)</p>	
<p>version 4UREP10.../...E...</p> 	<p>versions: 4UREP10.../...E...- MAB; 4UREP10.../...E...- M0</p>  <p>4UREP10.../...E...- MA 4UREP10.../...E...- MB</p> 
<p>external supply (X); external drain (Y)</p>	
<p>version 4UREP10.../...</p> 	<p>wersje: 4UREP10.../...- MAB; 4UREP10.../...- M0</p>  <p>4UREP10.../...- MA 4UREP10.../...- MB</p> 

DIAGRAMS

Hydraulic diagrams for 2-position versions UREP10...A... (positions a, 0) with various pilot supply (X) and pilot drain (Y)

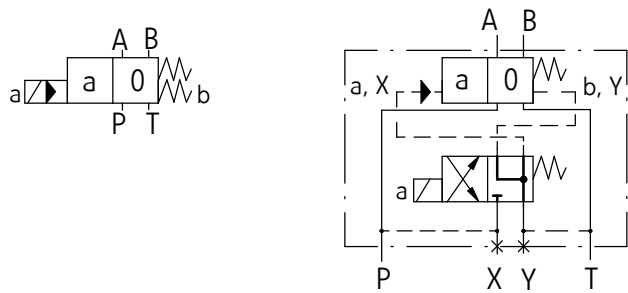
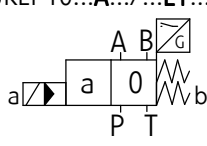
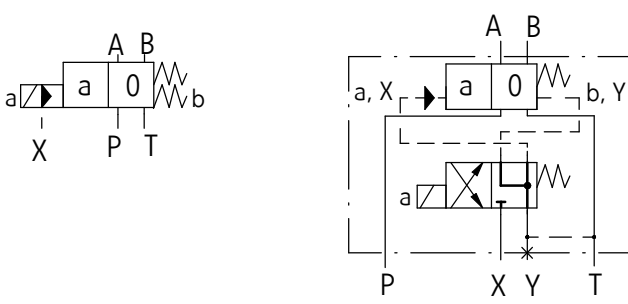
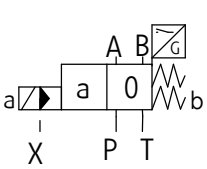
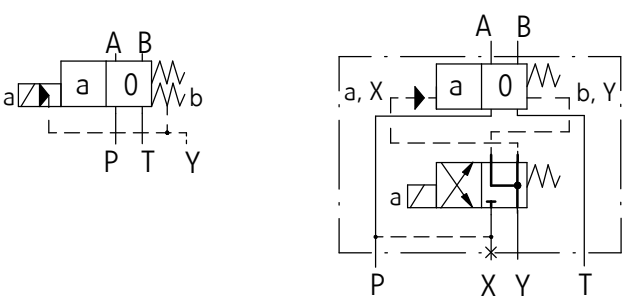
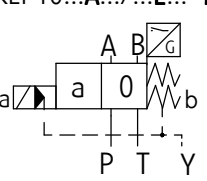
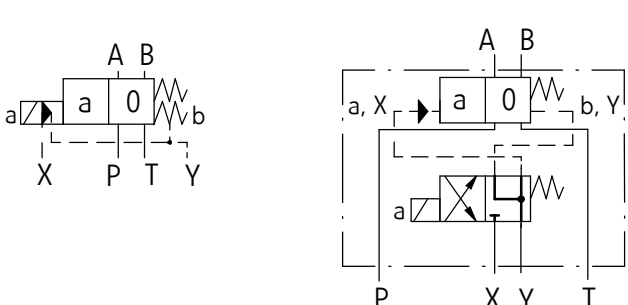
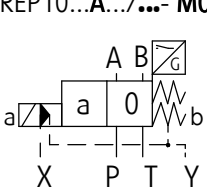
<p>simplified and detailed diagrams for standard 2-position (a, 0) versions 4UREP10...A.../...</p>	<p>simplified diagrams for 2-position (a, 0) versions with a type M spool position sensor 4UREP10...A.../...- M...</p>
<p>internal supply (X); internal drain (Y) - configuration not available for versions with spools GA, HA (diagrams acc. to page 7)</p>	
<p>version 4UREP10.../...ET...</p> 	<p>versions: 4UREP10...A.../...ET...- MA; 4UREP10...A.../...ET...- M0</p> 
<p>external supply (X); internal drain (Y)</p>	
<p>version 4UREP10.../...T...</p> 	<p>versions: 4UREP10...A.../...T...- MA; 4UREP10...A.../...T...- M0</p> 
<p>internal supply (X); external drain (Y) - configuration not available for versions with spools GA, HA (diagrams acc. to page 7)</p>	
<p>version 4UREP10.../...E...</p> 	<p>versions: 4UREP10...A.../...E...- MA; 4UREP10...A.../...E...- M0</p> 
<p>external supply (X); external drain (Y)</p>	
<p>version 4UREP10.../...</p> 	<p>versions: 4UREP10...A.../...- MA; 4UREP10...A.../...- M0</p> 

DIAGRAMS

Hydraulic diagrams for 2-position versions UREP10...B... (positions 0, b)
with various pilot supply (X) and pilot drain (Y)

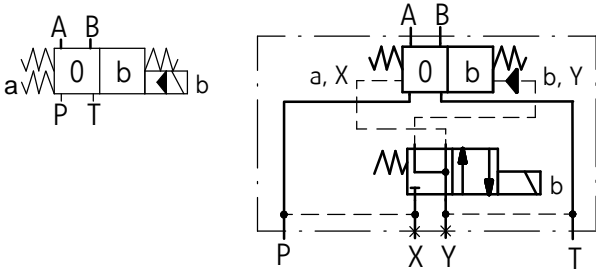
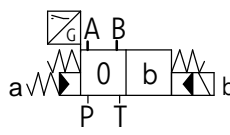
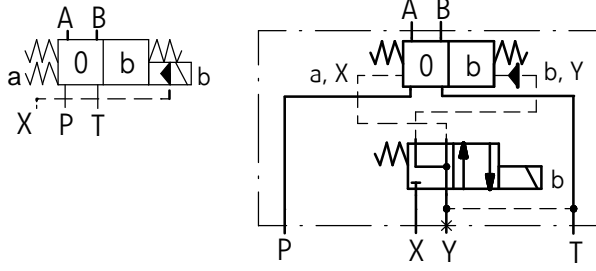
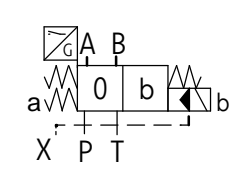
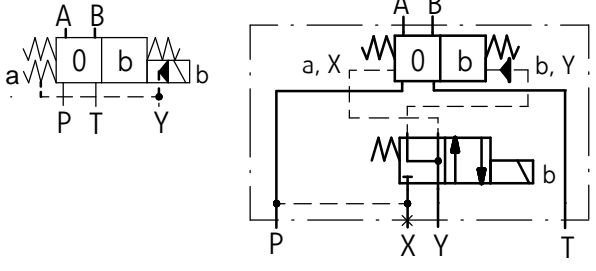
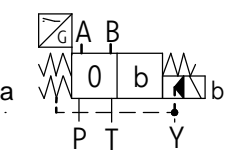
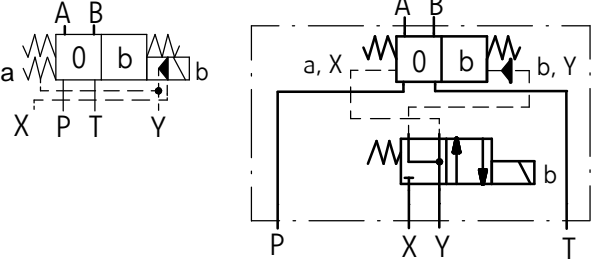
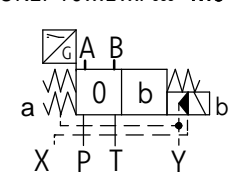
<p>simplified and detailed diagrams for standard 2-position (0, b) versions 4UREP10...B...</p>	<p>simplified diagrams for 2-position (0, b) versions with a type M spool position sensor 4UREP10...B.../...- M...</p>
<p>internal supply (X); internal drain (Y) - configuration not available for versions with spools GB, HB (diagrams acc. to page 7)</p>	
<p>version 4UREP10...B.../...ET...</p> 	<p>versions: 4UREP10...B.../...ET...- MB; 4UREP10...B.../...ET...- M0</p> 
<p>external supply (X); internal drain (Y)</p>	
<p>version 4UREP10...B.../...T...</p> 	<p>versions: 4UREP10...B.../...T...- MB; 4UREP10...B.../...T...- M0</p> 
<p>internal supply (X); external drain (Y) - configuration not available for versions with spools GB, HB (diagrams acc. to page 7)</p>	
<p>version 4UREP10...B.../...E...</p> 	<p>versions: 4UREP10...B.../...E...- MB; 4UREP10...B.../...E...- M0</p> 
<p>external supply (X); external drain (Y)</p>	
<p>version 4UREP10...B.../...</p> 	<p>versions: 4UREP10...B.../...- MB; 4UREP10...B.../...- M0</p> 

DIAGRAMS

Hydraulic diagrams for 2-position versions UREP10... (positions a, b) with various pilot supply (X) and pilot drain (Y)

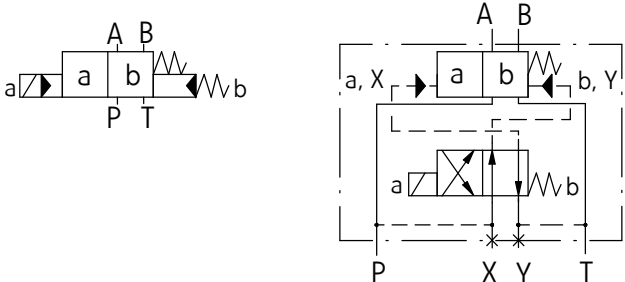
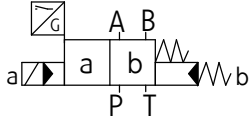
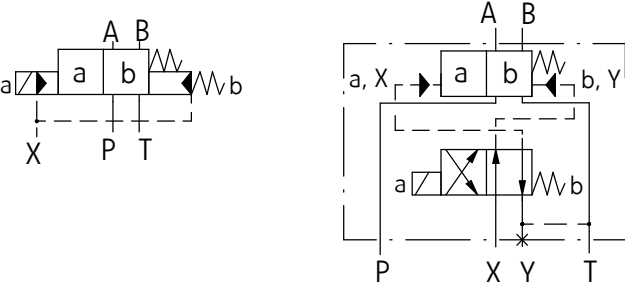
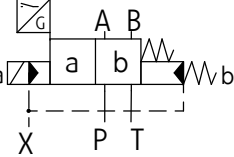
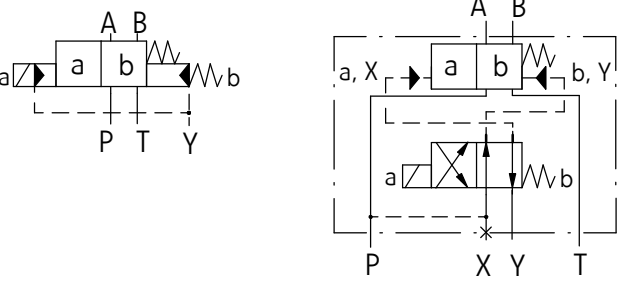
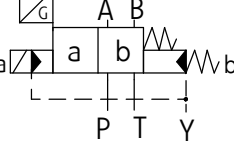
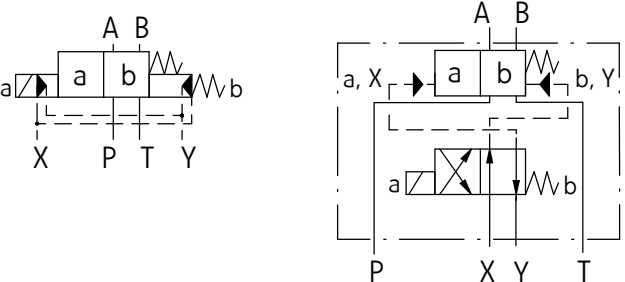
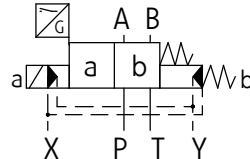
<p>simplified and detailed diagrams for standard 2-position (a, b) versions 4UREP10...</p>	<p>simplified diagrams for 2-position (a, b) versions with a type M spool position sensor 4UREP10.../...- M...</p>
<p>internal supply (X); internal drain (Y) - configuration not available for version with spool C (diagrams acc. to page 7)</p>	
<p>version 4UREP10.../...ET...</p> 	<p>versions: 4UREP10.../...ET...- MA; 4UREP10.../...ET...- MB</p> 
<p>external supply (X); internal drain (Y)</p>	
<p>version 4UREP10.../...T...</p> 	<p>versions: 4UREP10.../...T...- MA; 4UREP10.../...T...- MB</p> 
<p>internal supply (X); external drain (Y) - configuration not available for version with spool C (diagrams acc. to page 7)</p>	
<p>version 4UREP10.../...E...</p> 	<p>versions: 4UREP10.../...E...- MA; 4UREP10.../...E...- MB</p> 
<p>external supply (X); external drain (Y)</p>	
<p>version 4UREP10.../...</p> 	<p>versions: 4UREP10.../...- MA; 4UREP10.../...- MB</p> 

DIAGRAMS

Graphic symbols for spools

3-position versions 4UREP10...

working and indirect positions

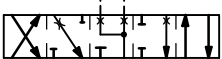
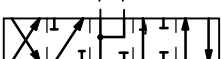
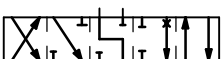
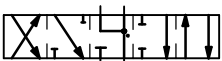
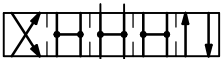
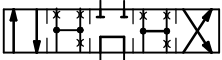
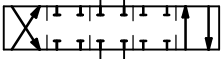
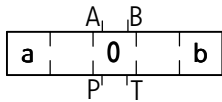

working positions

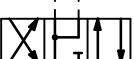
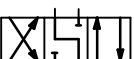
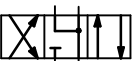
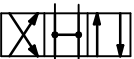
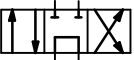
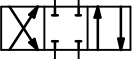
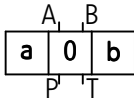

2-position versions

4UREP10...A... (positions a, 0)

working and indirect positions

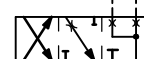
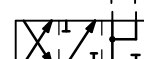
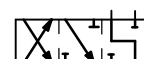
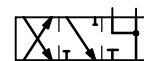
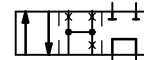
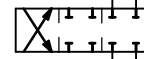
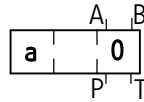

working positions

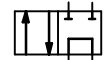
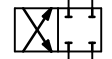
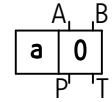

4UREP10...B... (positions 0, b)

working and indirect positions

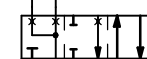
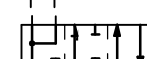
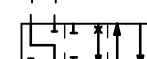
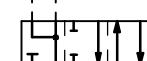
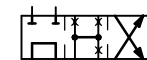
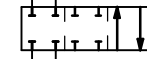
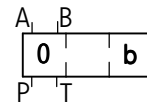

working positions

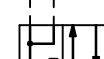
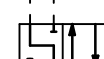
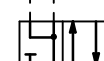
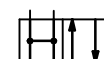
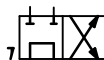
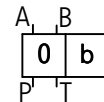

4UREP10... (positions a, b)

working and indirect positions

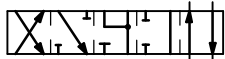
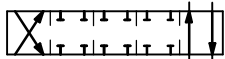
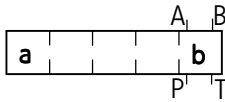

working positions

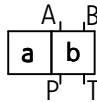

NOTES:

For 3-position directional spool valves, the position of directional spool valve is executed by individual spools acc. to diagrams of connections, constituting reflection of schemes presented above is obtained by alternative connection of plugs for suitable solenoid coils of preliminary directional valve.

OVERALL AND CONNECTION DIMENSIONS

3-position standard versions 4UREP10...S...D1...

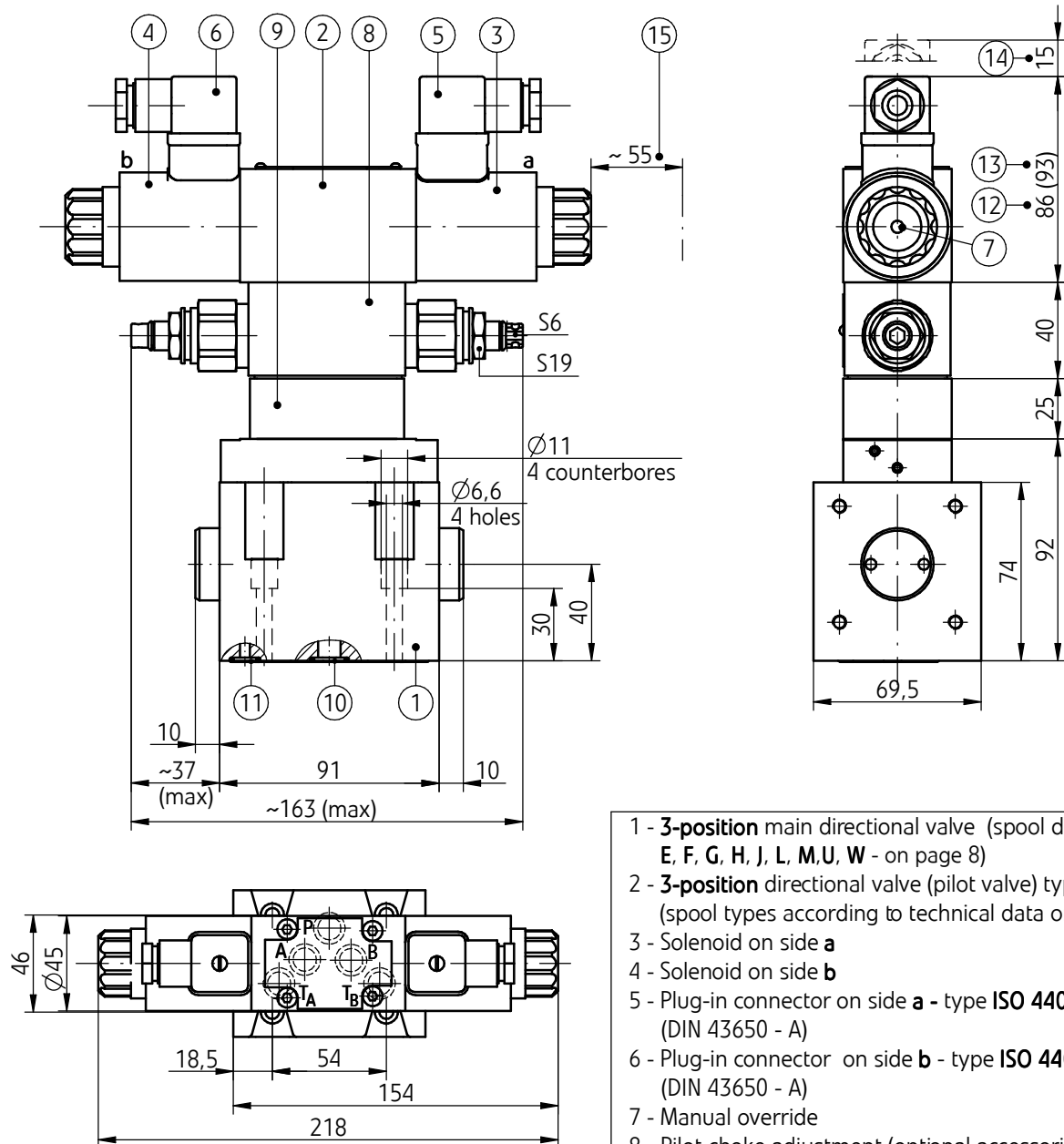

- 1 - **3-position** main directional valve (spool diagrams: **E, F, G, H, J, L, M, U, W** - on page 8)
- 2 - **3-position** directional valve (pilot valve) type **WE6...** (spool types according to technical data on page 3)
- 3 - Solenoid on side **a**
- 4 - Solenoid on side **b**
- 5 - Plug-in connector on side **a** - type **ISO 4400** (DIN 43650 - A)
- 6 - Plug-in connector on side **b** - type **ISO 4400** (DIN 43650 - A)
- 7 - Manual override
- 8 - Pilot choke adjustment (optional accessories - acc. to page 12)
- 9 - Pressure ratio valve (optional accessories - acc. to page 12)
- 10 - Sealing ring **o-ring 12,42 x 1,78** - pcs 5/set (**P, TA, TB, A, B**)
- 11 - Sealing ring **o-ring 9,25 x 1,78** - pcs 2/set (**X, Y**)
- 12 - Overall dimension for directional valve with electrical connection for **DC**
- 13 - Overall dimension for directional valve with electrical connection for **AC** (plug-in connector with rectifier)
- 14 - Space for disassembly of plug-in connectors item 5, 6
- 15 - Space for disassembly of solenoid coils - item 3, 4

NOTE:

available porting patterns - acc to page 11

OVERALL AND CONNECTION DIMENSIONS

2-position standard versions: 4UREP10...S...D1...; 4UREP10...A...S...D1...; 4UREP10...B...S...D1...

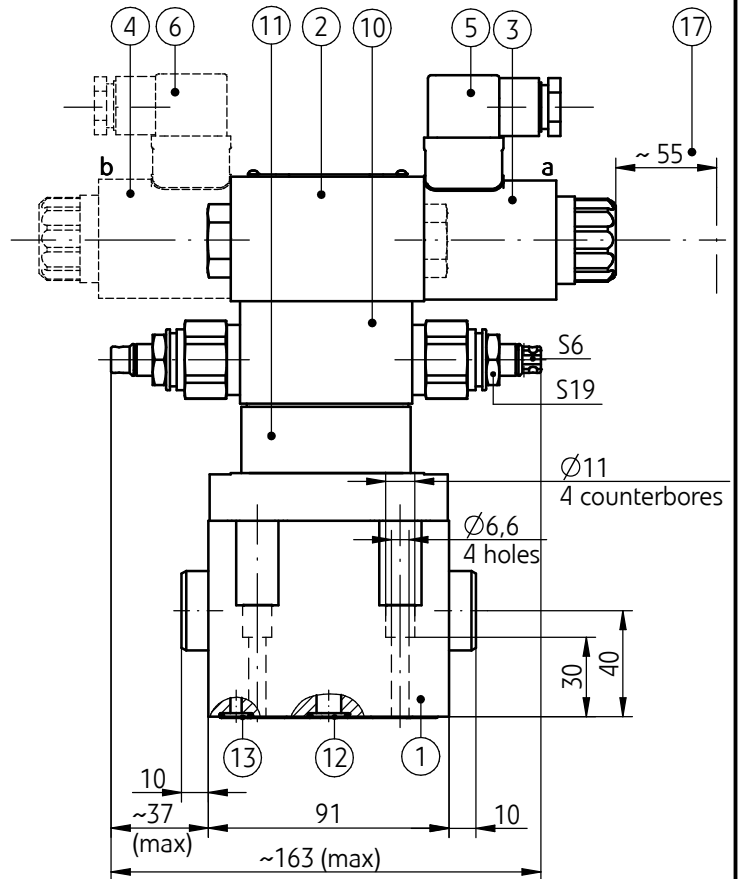
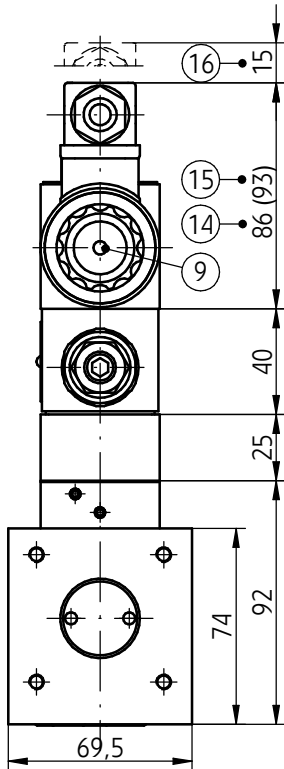

1 - 2-position main directional valve - versions:

- 4UREP10... (spool diagrams: C, D, K - acc. to page 8)
- 4UREP10...A... (spool diagrams: EA, FA, GA, HA, JA, LA, MA, UA, WA - acc. to page 8)
- 4UREP10...B... (spool diagrams: EB, FB, GB, HB, JB, LB, MB, UB, WB - acc. to page 8)

2 - 2-position directional valve (pilot valve) type WE6... (spool types according to technical data on page 3)

3 - Solenoid on side a - versions: 4UREP10...; 4UREP10...A...

4 - Solenoid on side b - version 4UREP10...B...

5 - Plug-in connector on side a - type ISO 4400 (DIN 43650 - A)

6 - Plug-in connector on side b - type ISO 4400 (DIN 43650 - A)

7 - Overall dimension for versions: 4UREP10...; 4UREP10...A...

8 - Overall dimension for version 4UREP10...B...

9 - Manual override

10 - Pressure ratio valve (optional accessories - acc. to page 12)

11 - Pilot choke adjustment (optional accessories - acc. to page 12)

12 - Sealing ring o-ring 12,42 x 1,78 - pcs 5/set (P, T_A, T_B, A, B)

13 - Sealing ring o-ring 9,25 x 1,78 - pcs 2/set (X, Y)

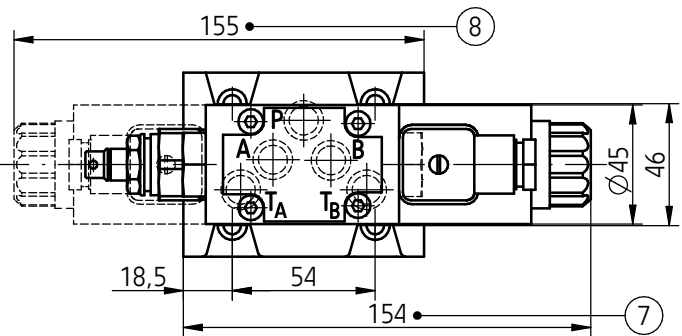

14 - Overall dimension for directional valve with electrical connection for DC

15 - Overall dimension for directional valve with electrical connection for AC (plug-in connector with rectifier)

16 - Space for disassembly of plug-in connectors item 5, 6

17 - Space for disassembly of solenoid coils - item 3, 4

NOTE:

available porting patterns - acc. to page 11

OVERALL AND CONNECTION DIMENSIONS

porting pattern options

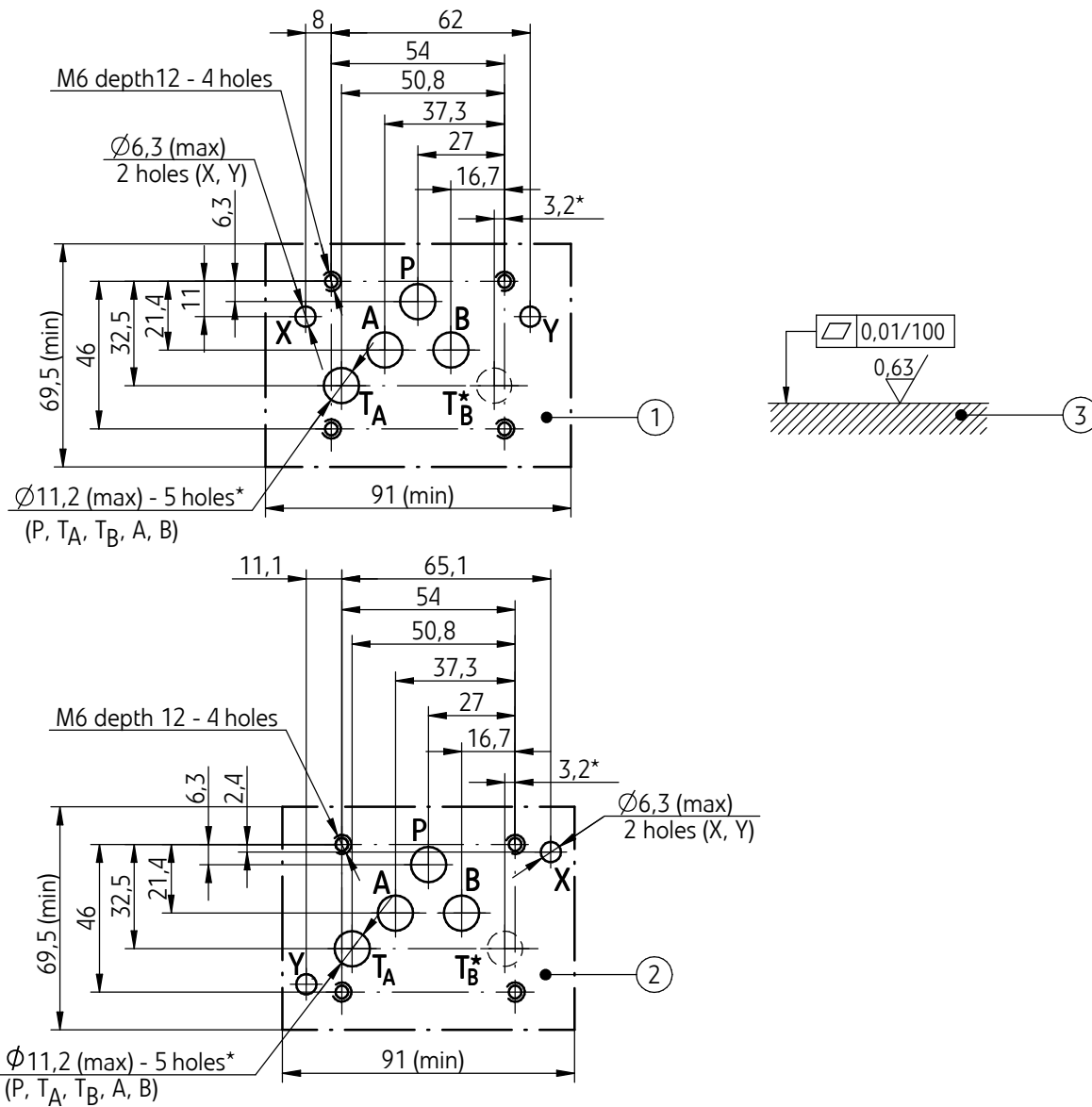

- 1 - Configuration of subplate surface holes in accordance with the standard **ISO 4401** designation **ISO 4401-05-05-0-05** (CETOP R05) fixing screws **M6 x 40 - 10.9** - pcs 4/set acc. to **PN - EN ISO 4762**; tightening torque **Md = 15 Nm**
- 2 - Configuration of subplate surface holes in accordance with the standard **CETOP** designation **CETOP 4.2-4 P05** (CETOP P05) fixing screws **M6 x 40 - 10.9** - pcs 4/set acc. to **PN - EN ISO 4762**; tightening torque **Md = 15 Nm**
- 3 - Subplate surface required

NOTE:

(*) - optional port **T** - connection with 1 hole **T** from the side of the hole **A** or **B** is enough - holes **T_A** and **T_B** are connected in the housing of directional spool valve.

ACCESSORIES FOR STANDARD VERSIONS OF THE DIRECTIONAL VALVE

Pilot choke adjustment

versions: 4UREP10.../...S...
4UREP10.../...S2...

Directional spool valve type **UREP10...** can be optionally provided with pilot choke adjustment (throttle check valve type **Z2FS6...**), which allows to adjust switching time directional spool valve.

The change of adjustment method of switching time (flow throttling):

- on inlet (version 4UREP10.../S...)
- on outlet (version 4UREP10.../S2...)

is made while mounting by rotating the pilot choke adjustment (3) o 180 degrees around its longitudinal axis. Rotation of the adjusting screw (5) clockwise increases and counterclockwise decreases the switching of the valve.

Screws **M5 x 110 - 10.9** acc. to **PN - EN ISO 4762** - pcs 4 fixing the adjustment (3) and the pilot valve (2) must be tightened with torque **Md = 9 Nm**.

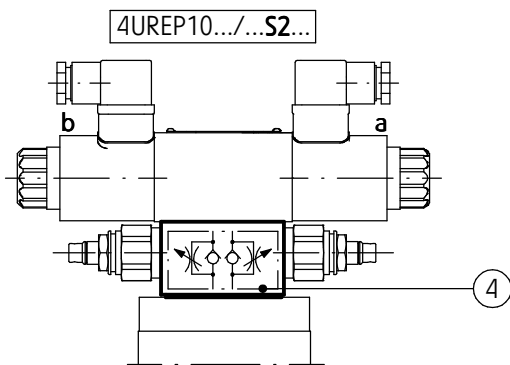
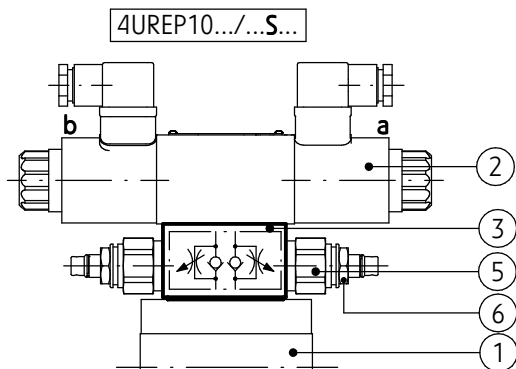

- | |
|--|
| <p>1 - Main valve
2 - Pilot valve
3 - Pilot choke adjustment with <u>adjustment of switching time at the inlet</u>
4 - Assembly method of pilot choke adjustment with <u>adjustment of switching time on outlet</u>
5 - Adjusting screw (socket S6)
6 - Locknut (S19)
7 - Pressure ratio valve</p> |
|--|

Pressure ratio valve

versions: 4UREP10.../...ET...D1...
4UREP10.../...E...D1...

The directional spool valve type **UREP10...** with internal pilot oil supply - versions: ...E...;...ET...at the pilot oil supply pressure exceeding 25 MPa must be equipped with a pressure ratio valve (7).

It causes the pilot pressure to be reduced at the ratio 1:0,66. The minimum control pressure when applying the pressure ratio valve must be increased by the ratio $1:0,66 = 1,515$.

The screws **M5 x 135 - 10.9** acc. to **PN - EN ISO 4762** pcs 4 fixing the pressure ratio valve (7), the pilot choke adjustment (3) and the pilot valve (2) must be tightened with torque **Md = 9 Nm**.

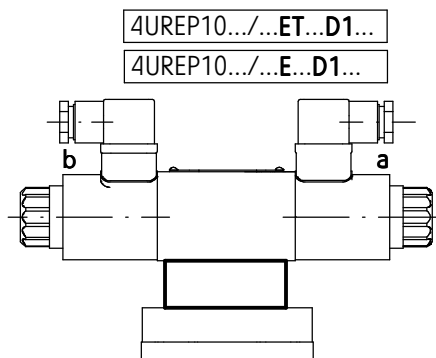
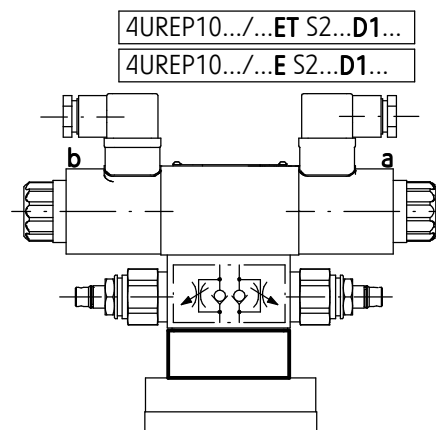
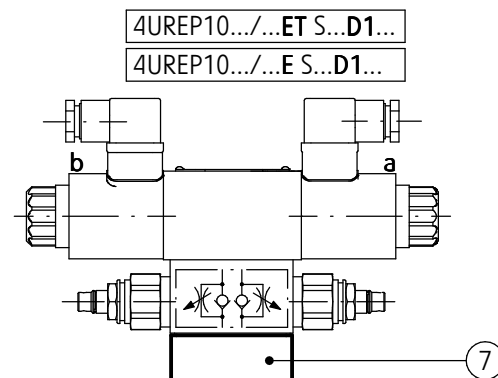

ACCESSORIES FOR STANDARD VERSIONS OF THE DIRECTIONAL VALVE

Pilot oil supply and pilot oil drain

Pilot oil supply X - external

Pilot oil drain Y - external

version 4UREP10.../...

In version 4UREP10.../... the pilot flow is taken externally through system through port X.

Drainage pilot flow is through independent port Y to tank.

Two the hole screws plugs (4) and (5) in ports X, Y must be mounted in the position like given on the drawing.

Pilot oil supply X - internal

Pilot oil drain Y - external

version 4UREP10.../...E...

In version 4UREP10.../...E... the pilot flow is taken internally from port P main directional valve.

Drainage pilot flow is through independent port Y to tank.

The hole screw plug (4) is dismounted, the hole screw plug (5) is mounted. Port X in a subplate should be plugged.

Pilot oil supply X - internal

Pilot oil drain Y - internal

version 4UREP10.../...ET...

In version 4UREP10.../...ET... the pilot flow is taken internally from port P main directional valve.

Drainage pilot flow is through internally port T to tank.

The hole screws plugs (4) and (5) is dismounted. Ports X and Y in a subplate must be plugged.

Pilot oil supply X - external

Pilot oil drain Y - internal

version 4UREP10.../...T...

In version 4UREP10.../...T... the pilot flow is taken internally from port P main directional valve.

Drainage pilot flow is through internally port T to tank.

The hole screw plug (4) is mounted, the hole screw plug (5) is dismounted. Port Y in a subplate should be plugged.

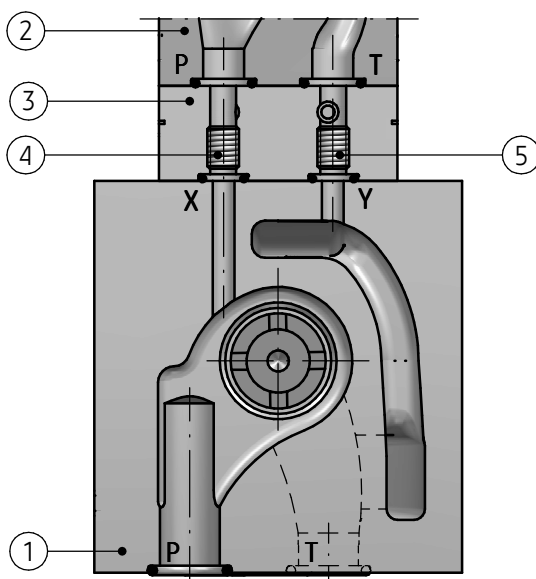

NOTES:

Options with **internal pilot oil supply**: ...E...; ...ET... (diagrams acc. to pages 4 to 8) are **not available** in versions:

- **3-position** with spools G, H
- **2-position (a, 0)** with spools GA, HA
- **2-position (0, b)** with spools GB, HB
- **2-position (a, b)** with spool C

The hole screw plugs - item 4, 5 are accessible after dismounting 4 screws (M5 x 70 with hexagon socket S4) fixing the pilot valve - item 2 and the transitive plate - item 3.

- | |
|--|
| 1 - Main valve body |
| 2 - Pilot valve body |
| 3 - Transitive plate |
| 4 - Hole screw plug M6 - 8.8 with hexagon socket S3 pilot oil supply (X) |
| 5 - Hole screw plug M6 - 8.8 with hexagon socket S3 pilot oil drain (Y) |

ACCESSORIES FOR STANDARD VERSIONS OF THE DIRECTIONAL VALVE

Throttle insert

version 4UREP10.../...B...

Directional valve type UREP10... can be equipped with throttle insert (3) in port P in pilot valve (2) which allows to **delay switching time** of the main valve.

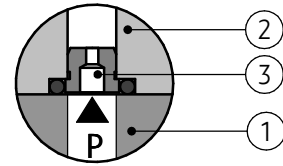

- 1 - Main valve body
- 2 - Pilot valve body
- 3 - Throttle insert

OPTIONAL ACCESSORIES FOR THE DIRECTIONAL VALVE

Spool position sensor type M

Technical data

Type of spool position sensor	inductive sensor type M with two alternative PNP type outputs
Supply voltage range of the sensor	24 VDC ^{+20%} _{-10%}
Max sensor load current	40 0 mA
Sensor connection type	external thread M12 x 1; 4 poles (pins)
Degree of protection	IP 65
WARNING: M type inductive sensors must not be connected serially.	

Diagrams of electrical connection

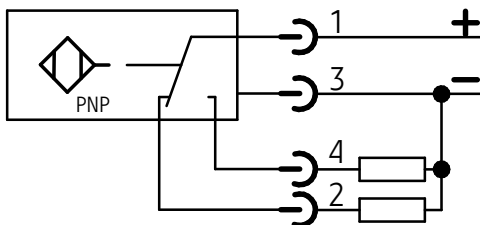

contact allocation
(pins of sensor connector)

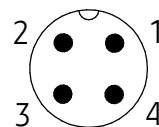

OPTIONAL ACCESSORIES FOR THE DIRECTIONAL VALVE

Spool position sensor type M

Diagrams for directional valves and status of sensors

status of sensor type M depending on position of the spool 0 - off, neutral, potential-free state at the output contact 1 - on, voltage state at the output contact		diagram for directional valve
<p>3-position versions 4UREP10.../...- MAB... a and b position monitoring (sensor at A and B side)</p>	<p>3-position versions 4UREP10.../...- M0... 0 position monitoring (sensor at A and B side)</p>	
<p>3-position versions 4UREP10.../...- MB... b position monitoring (sensor at the A)</p>	<p>3-position versions 4UREP10.../...- MA... a position monitoring (sensor at the B side)</p>	
<p>2-position (a, 0) versions 4UREP10.../...- MA... a position monitoring (sensor at the B side)</p>	<p>2-position (a, 0) versions 4UREP10.../...- M0... 0 position monitoring (sensor at the B side)</p>	
<p>2-position (0, b) versions 4UREP10...B.../...- MB... b position monitoring (sensor at the A side)</p>	<p>2-position (0, b) versions 4UREP10...B.../...- M0... b position monitoring (sensor at the A side)</p>	
<p>2-position (a, b) versions 4UREP10.../...- MA... a position monitoring (sensor at the A side)</p>	<p>2-position (a, b) versions 4UREP10.../...- MB... b position monitoring (sensor at the A side)</p>	

OVERALL DIMENSIONS OF THE VALVE WITH OPTIONAL ACCESSORIES

versions with a spool position sensor type M

NOTES:

- other dimensions, item description acc. to standard version valve drawings - see pages 9, 10; porting pattern options and required state of the connection surface - see page 11; overall dimensions, connection and operation requirements of spool position sensor shown on the drawing below are applicable to all versions of the directional valve equipped with the sensor type M
- in compliance with PN - EN 693, the valve should not be equipped with a manual override.

3-position versions

a, b or O position monitoring, sensor at the A and B sides

versions: 4UREP10.../...- MAB...

4UREP10.../...- MO...

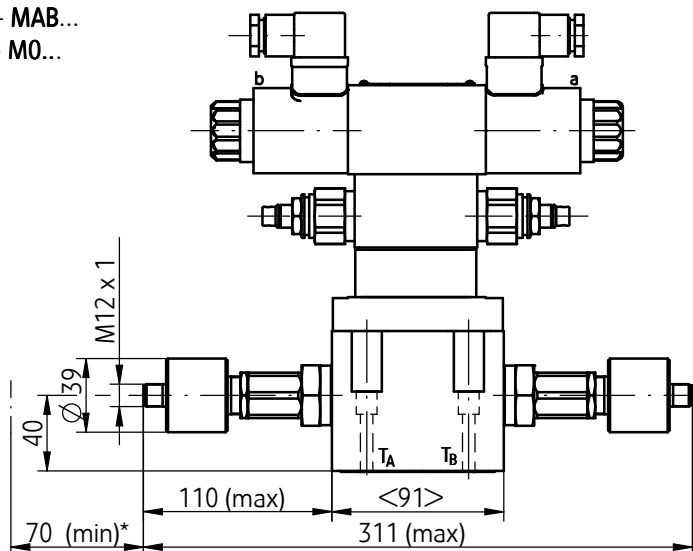

NOTE:

(*) - distance for mounting the plug-in connector and the sensor cable (the plugs not shown on the drawing, supplied on a separate order acc. to data sheet WK 499 963).

NOTES:

- the valve with the spool position sensor has been factory calibrated, any further adjustments with in the valve can be made only by the producer
- in case of any defect of the sensor or the valve, the whole valve should be replaced

3-position versions

a position monitoring, sensor at the B side

version: 4UREP10.../...- MA...

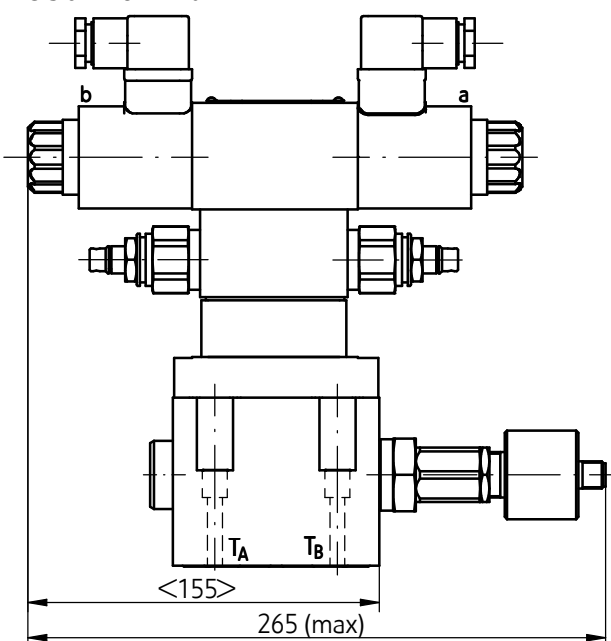

3-position versions

b position monitoring, sensor at the A side

version: 4UREP10.../...- MB...

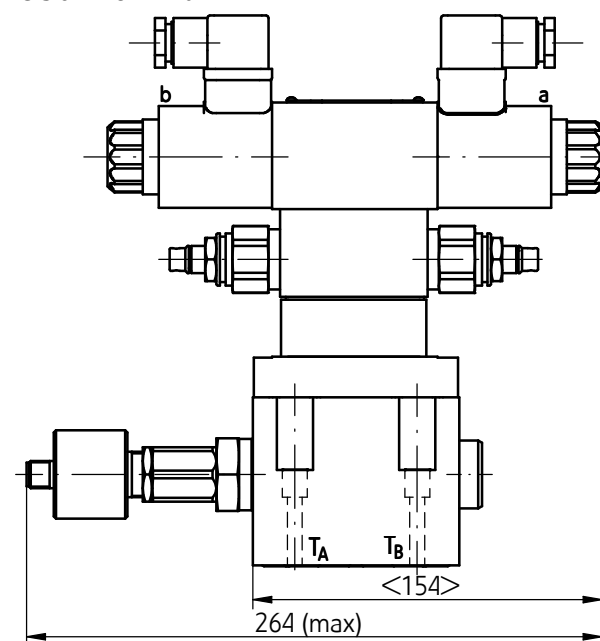

OVERALL DIMENSIONS OF THE VALVE WITH OPTIONAL ACCESSORIES

versions with a spool position sensor type M

2-position (a, b) versions

a or b position monitoring, sensor at the A side

versions: 4UREP10.../...- MA...

4UREP10.../...- MB...

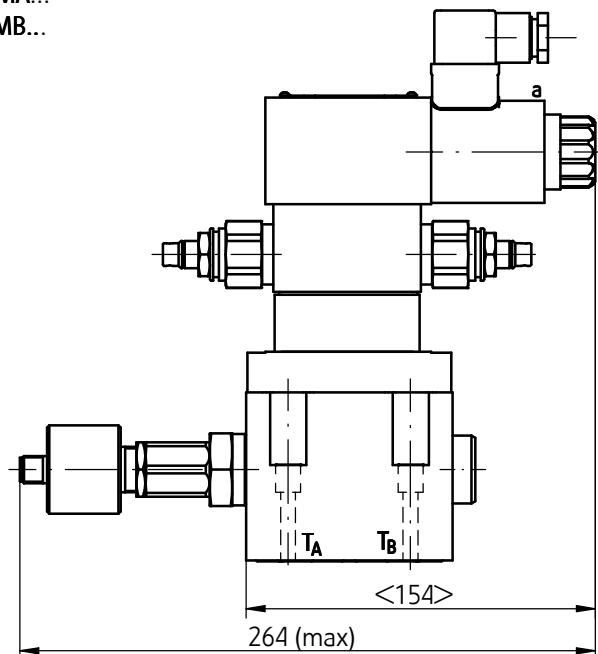

2-position (a, 0) versions

a or 0 position monitoring, sensor at the B side

versions: 4UREP10.../...- MA...

4UREP10.../...- M0...

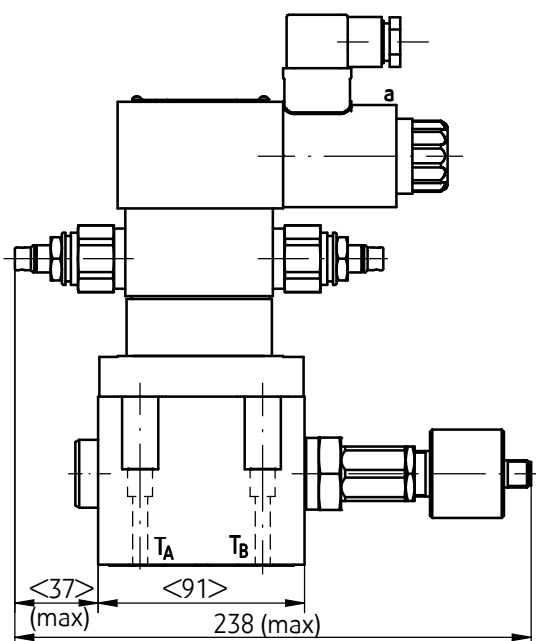

2-position (0, b) versions

b or 0 position monitoring, sensor at the A side

versions: 4UREP10.../...- MB...

4UREP10.../...- M0...

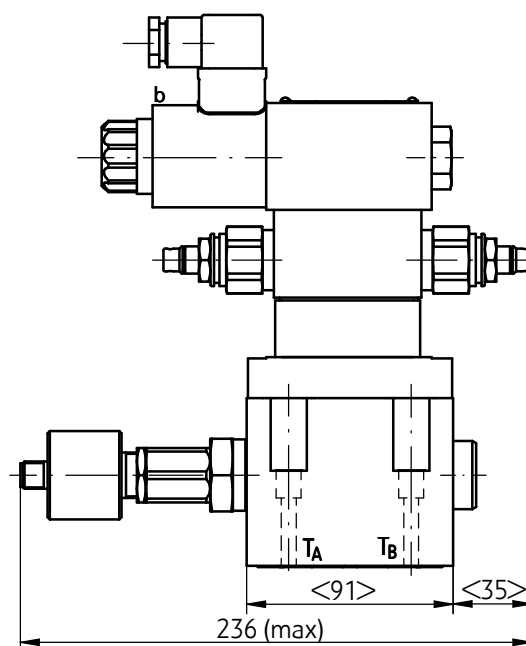

HOW TO ORDER

				*
--	--	--	--	---

Further requirements in clear text

(to be agreed with the manufacturer)

Sealing

NBR (for fluids on mineral oil base)

= **no designation**

FKM (for fluids on phosphate ester base)

= V

Pressure ratio valve

without pressure ratio valve

= **no designation**

with pressure ratio valve

= D1

Throttle insert in port P of the pilot valve

without throttle insert

= **no designation**

throttle insert ϕ 0,8

= B 08

throttle insert ϕ 1,0

= B 10

throttle insert ϕ 1,2

= B 12

NOTES:

The directional valve should be ordered according to the above coding.

The symbols in bold indicate the preferred versions, available in short delivery time.

Coding example: 4UREP10 E 62/G24 N ET Z4

PERFORMANCE CURVES

measured at viscosity $\nu = 41 \text{ mm}^2/\text{s}$ and temperature $t = 50^\circ\text{C}$

Flow resistance curves

characteristic curves $\Delta p(Q)$ for directional spool valve type UREP10... with various spool types

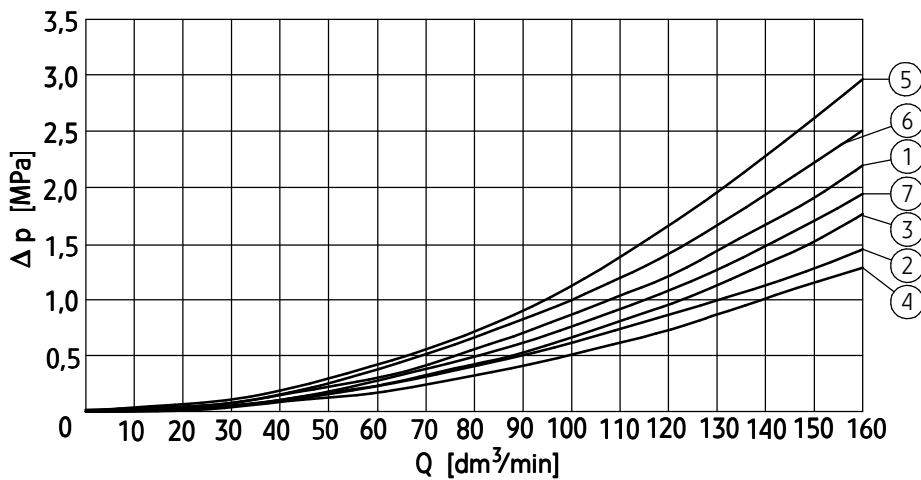

spool symbol	characteristic curve number				
	flow direction				
shifted positions diagrams acc. to page 8	P → A	P → B	A → T	B → T	P → T
	C	1	1	4	4
D, E	3	3	4	4	-
G	5	5	1	1	-
H	3	3	2	2	-
J, K	3	3	1	1	-
initial position (0) diagrams acc. to page 8	flow direction				
	P → A	P → B	A → T	B → T	P → T
G	-	-	-	-	6
H	-	-	-	-	7

Operating limits curves

characteristic curves $p-Q$ for directional spool valve type UREP10... with various spool types

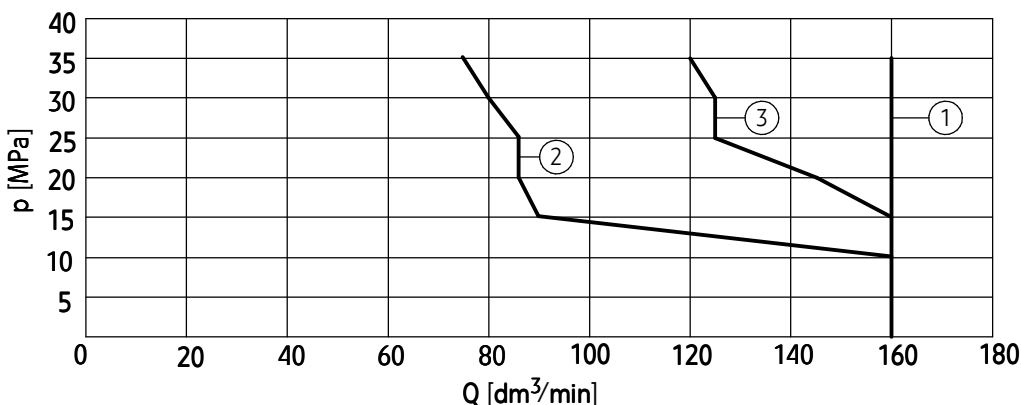

spool symbol diagrams acc. to page 8	characteristic curve number
C, D, E, J, K	1
H	2
G	3

NOTES:

Above operating limits are related to symmetrical flow through all ports i.e. if the oil flows from port P to port A, then the same flow rate is from port B to port T (applied to directional spool valves with 4 service ports). Degree of asymmetry affects adversely the parameters.

SUBPLATES AND FIXING SCREWS

Subplates must be ordered according to data sheet

WK 496 520 *. Subplate symbols:

G 66/01 - threaded connections G 3/8

G 67/01 - threaded connections **G 1/2**

G 89/01 - threaded connections G 1/4

G 67/02 - threaded connections M22 x 1,5

G 534/01 - threaded connections G 3/4

Subplates and fixing screws **M6 x 40 - 10,9** - acc. to **PN - EN ISO 4762** - 4 pcs/set must be ordered separately.

Tightening torque **Md = 15 Nm.**

NOTES:

(*) - not applicable to version 4UREP10.../P...

Subplate symbol in bold is the preferred version available in short delivery time.

EXAMPLE OF APPLICATION IN HYDRAULIC SYSTEM

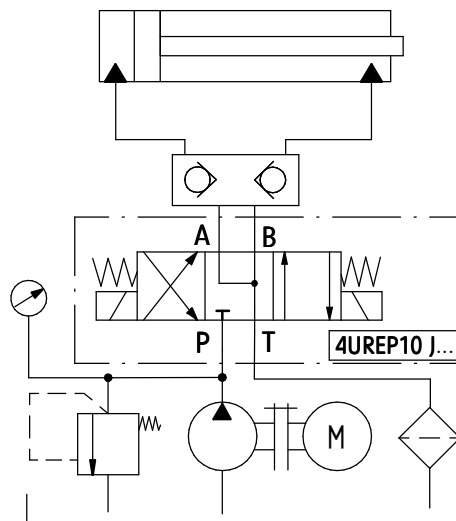

PONAR Wadowice S.A.
ul. Wojska Polskiego 29
34-100 Wadowice
tel. +48 33 488 21 00
fax. +48 33 488 21 03
www.ponar-wadowice.pl

